

A. Filler
MOULDING &
MILLWORK

Phone-(414) 353-8433
Fax-(414) 353-1456

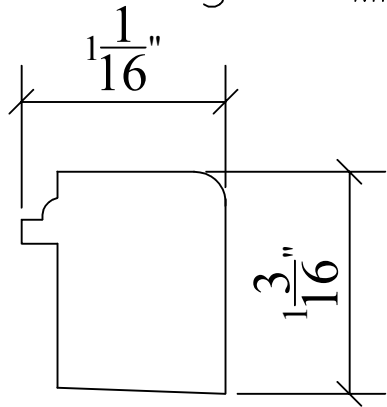

BB-1

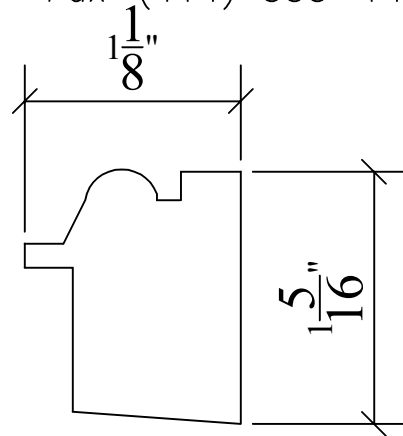

BB-2

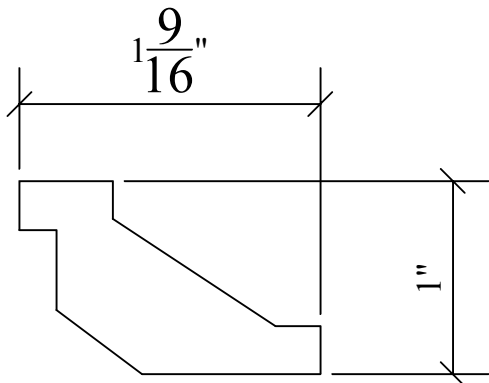

BB-3

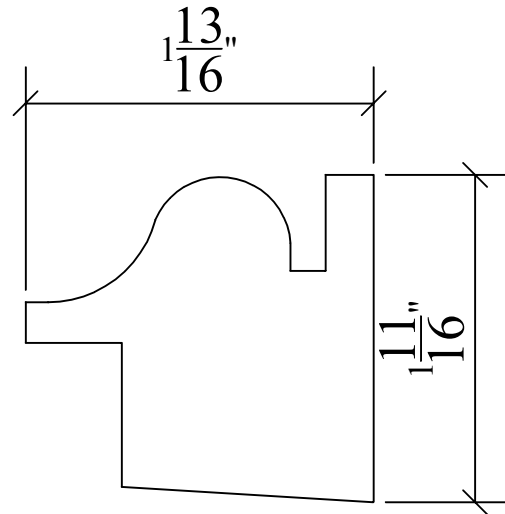

BB-4

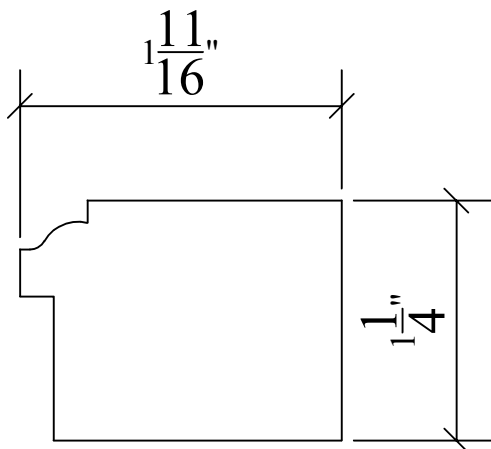

BB-5

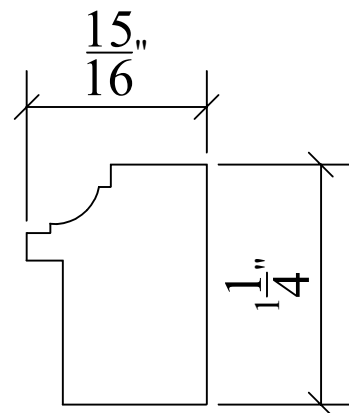

BB-6

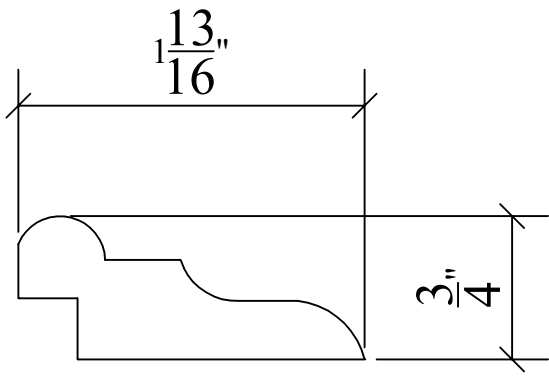

BB-55

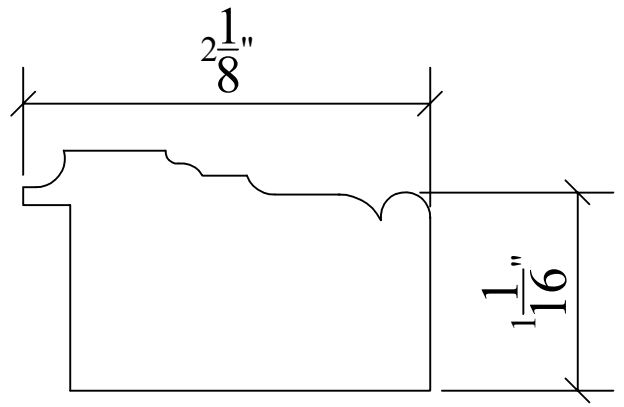

BB-56

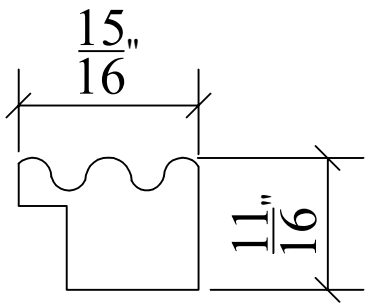

BB-57

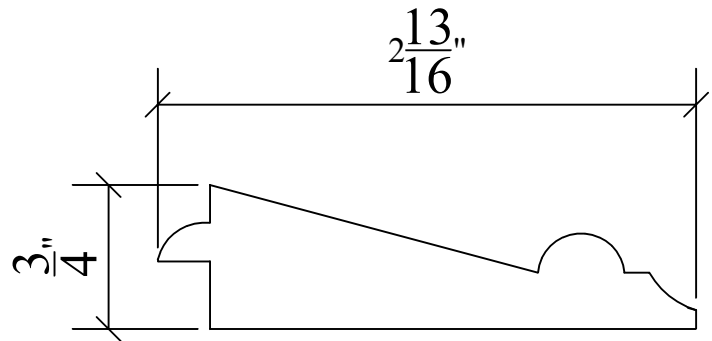

BB-58

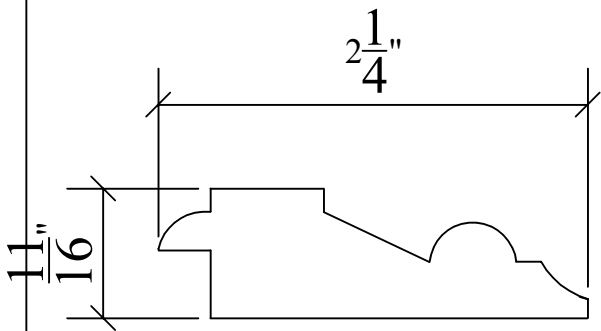

BB-59

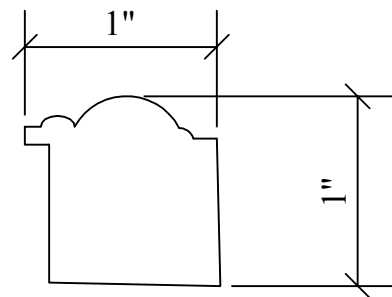

BB-60

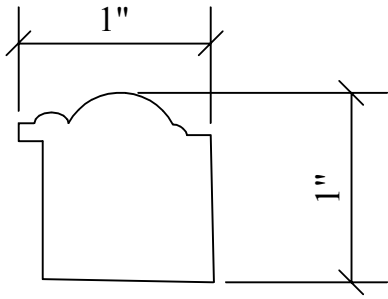

BB-61

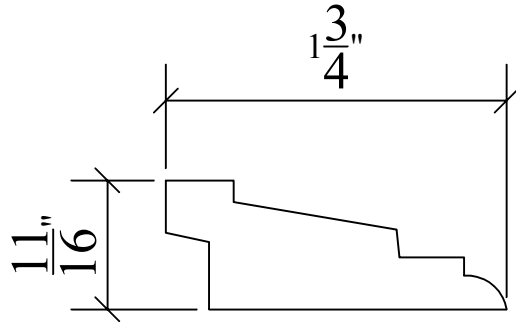

BB-62

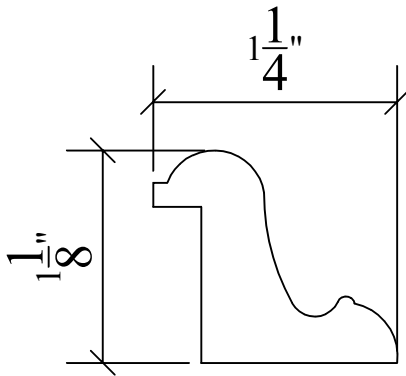

BB-63

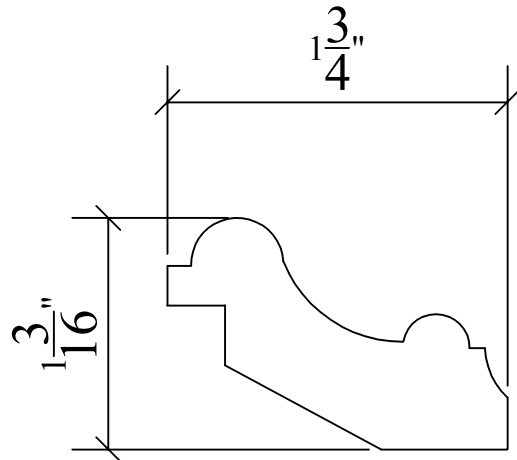

BB-64

A. Fillerger MOULDING & MILLWORK

Phone-(414) 353-8433
Fax-(414) 353-1456

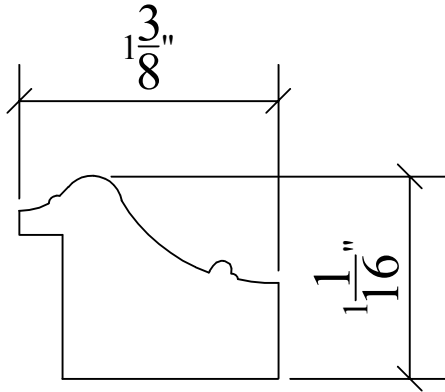

BB-7

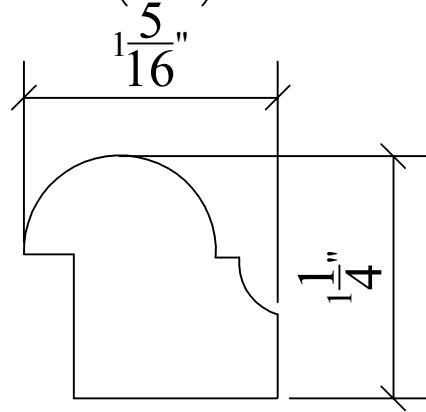

BB-8

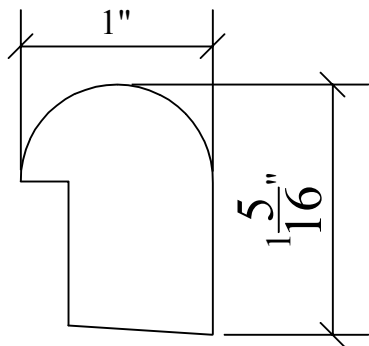

BB-9

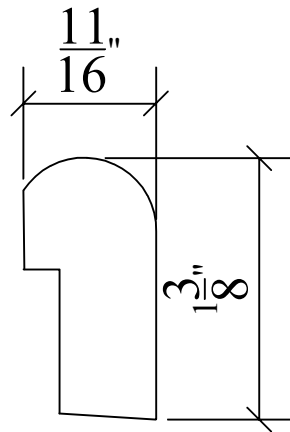

BB-10

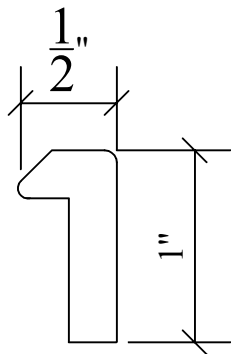

BB-11

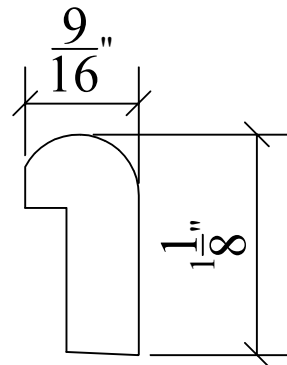

BB-12

A. Fillerger MOULDING & MILLWORK

Phone-(414) 353-8433
Fax-(414) 353-1456

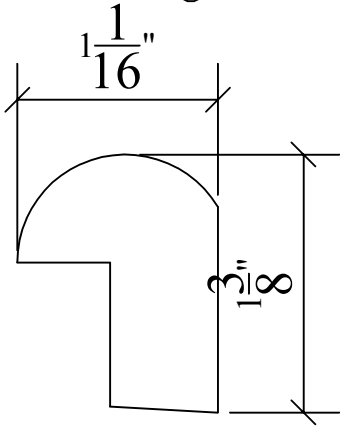

BB-13

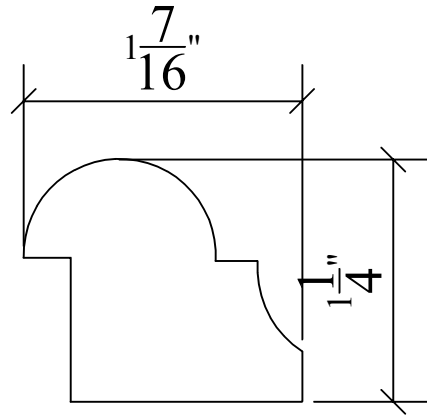

BB-14

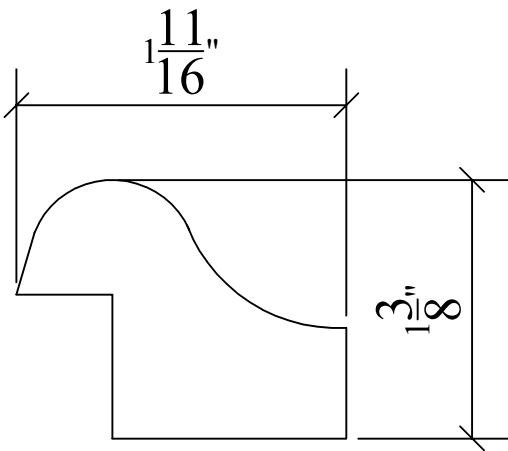

BB-15

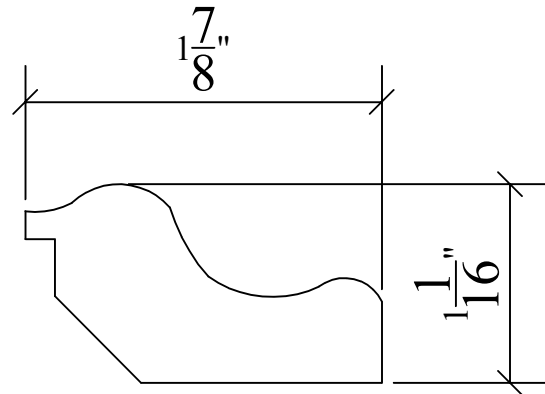

BB-16

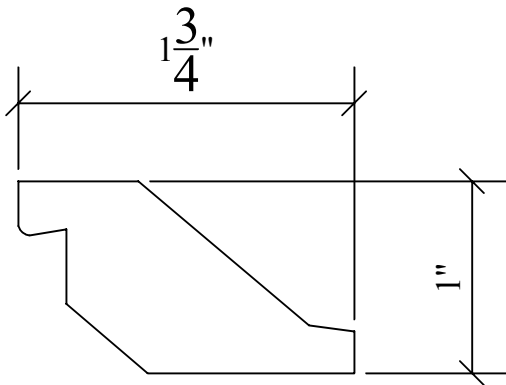

BB-17

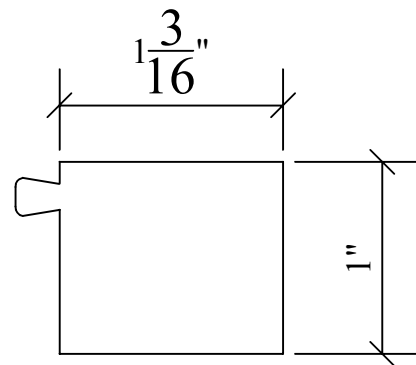

BB-18

A. Ffillinger MOULDING & MILLWORK

Phone-(414) 353-8433
Fax-(414) 353-1456

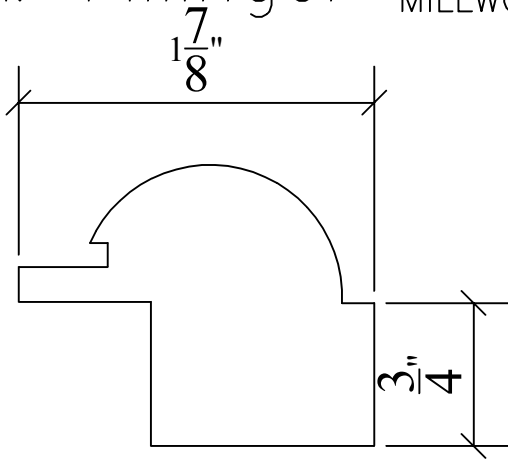

BB-19

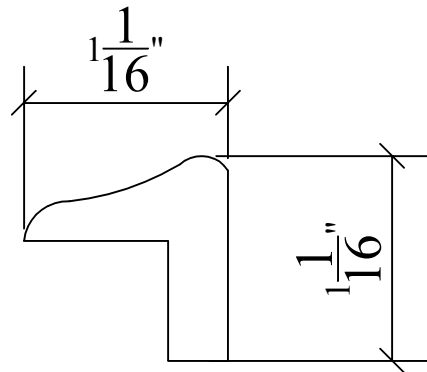

BB-20

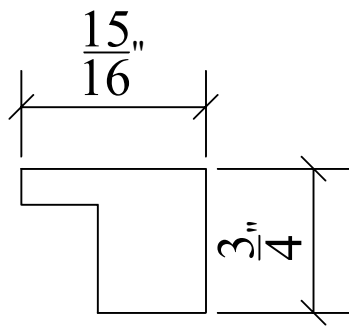

BB-21

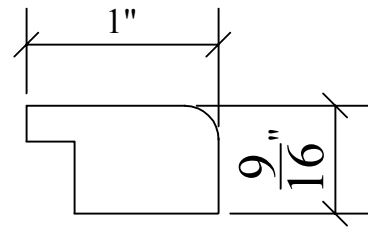

BB-22

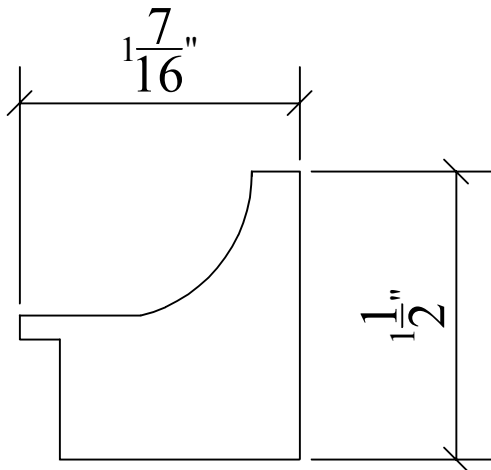

BB-23

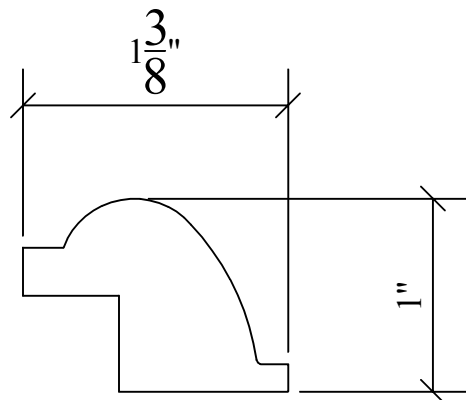

BB-24

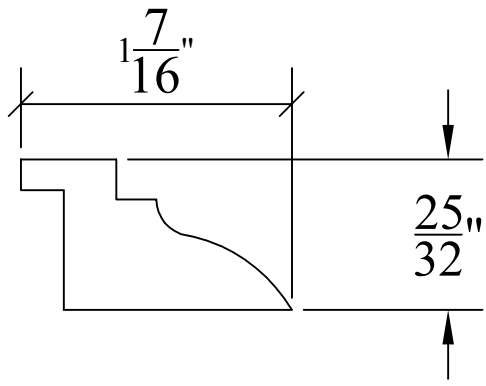

BB-25

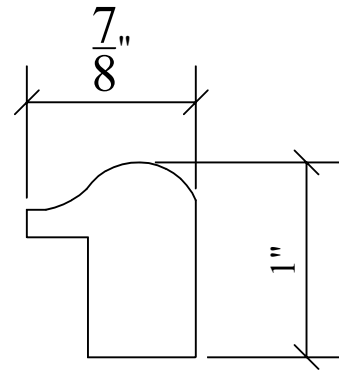

BB-26

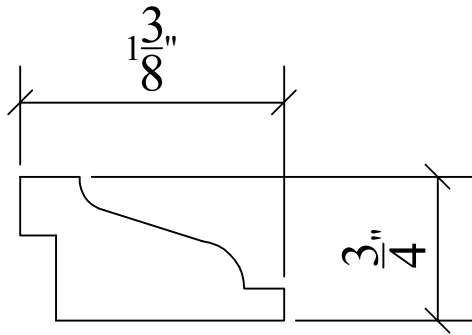

BB-27

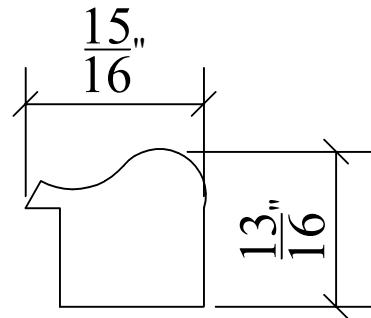

BB-28

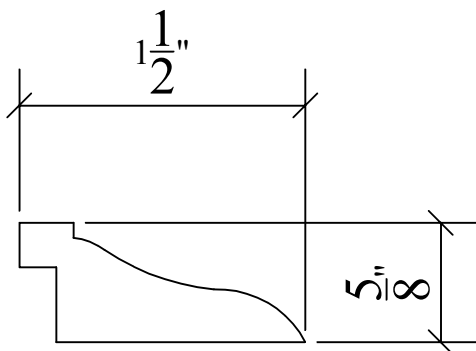

BB-29

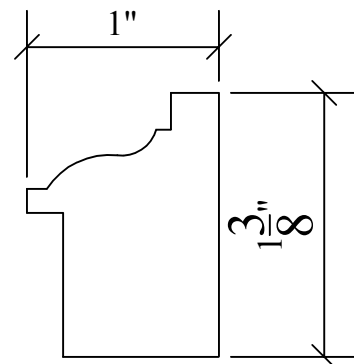

BB-30

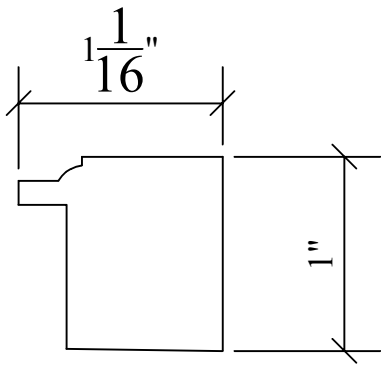

BB-31

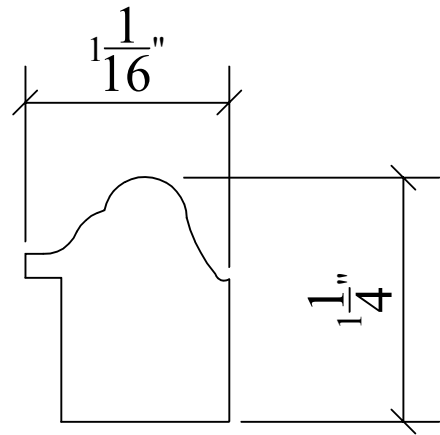

BB-32

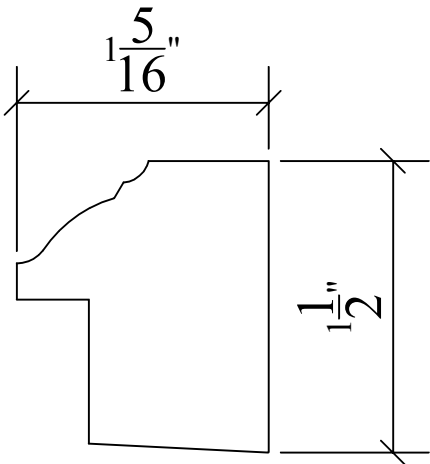

BB-33

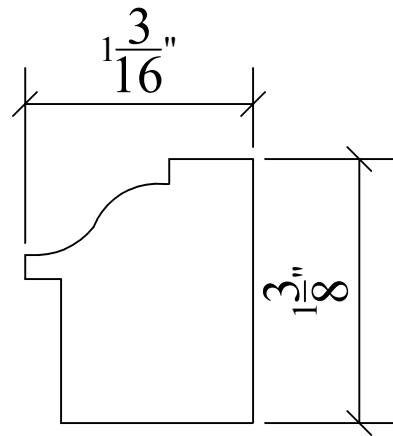

BB-34

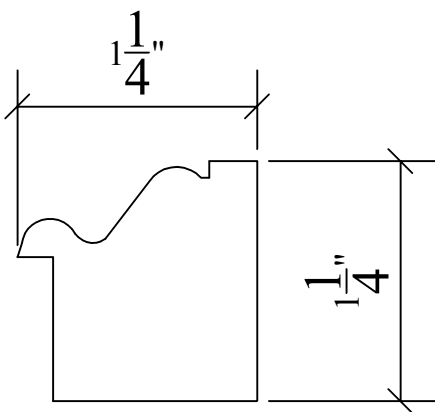

BB-35

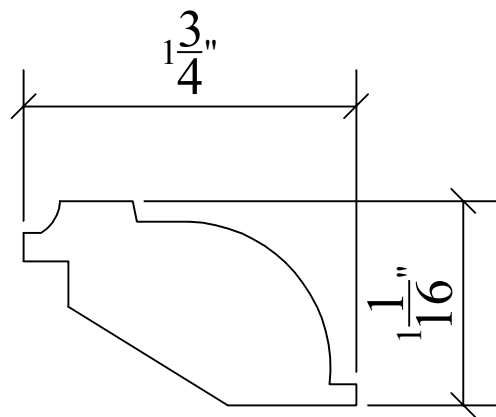

BB-36

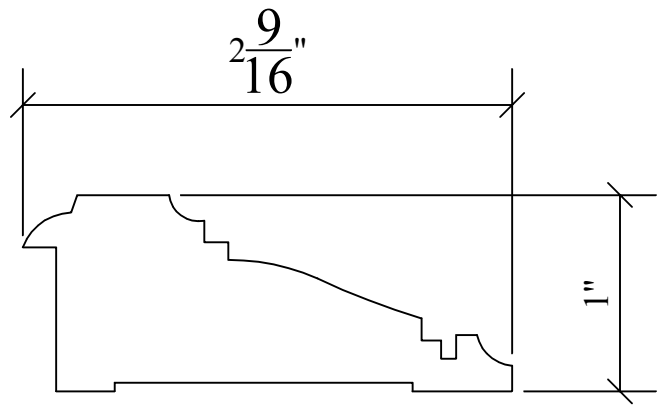
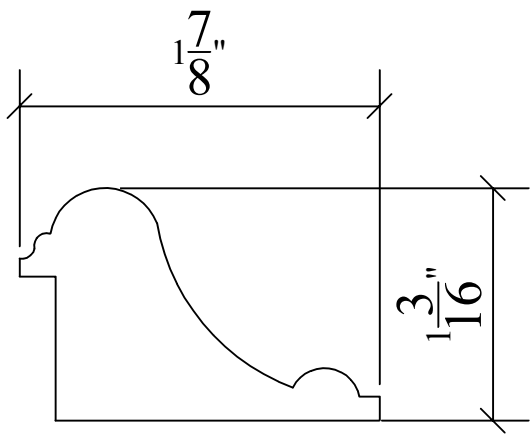

BB-37

BB-38

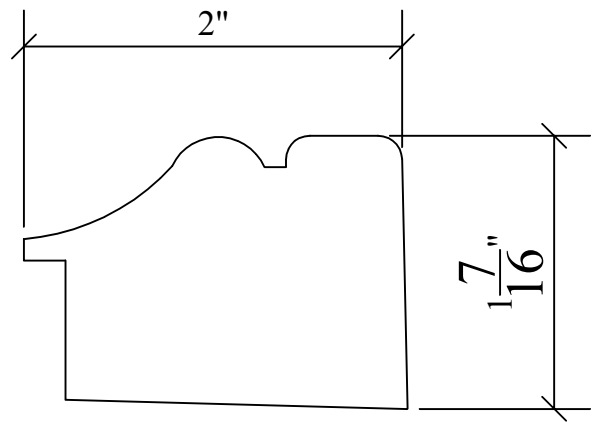
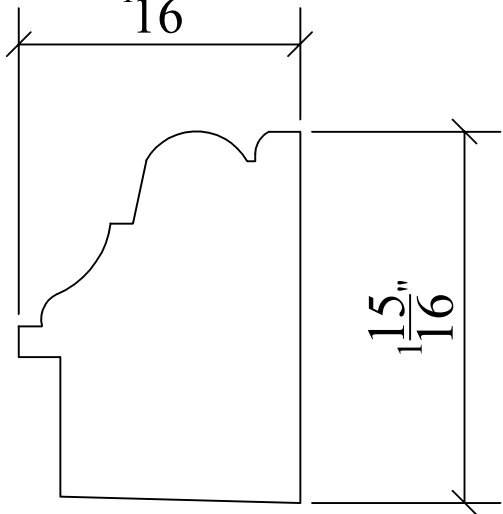

BB-39

BB-40

BB-41

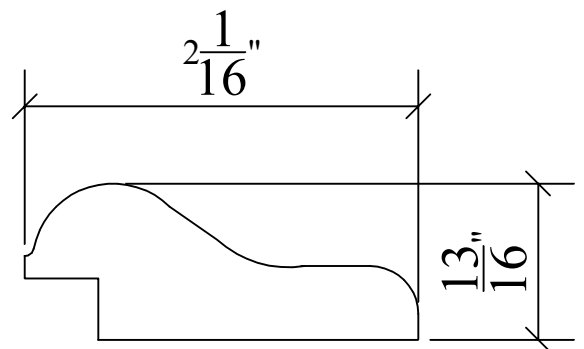
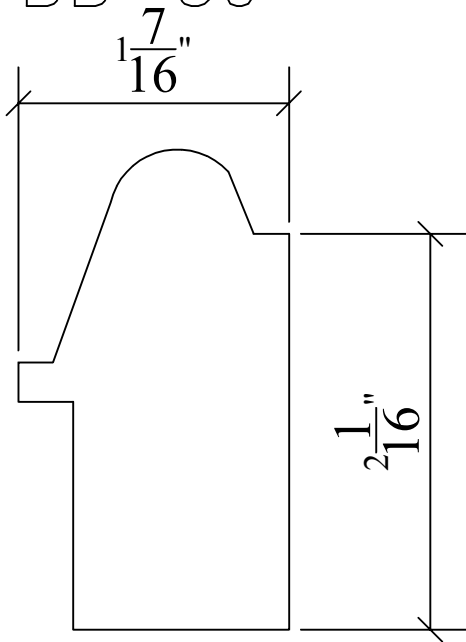

BB-42

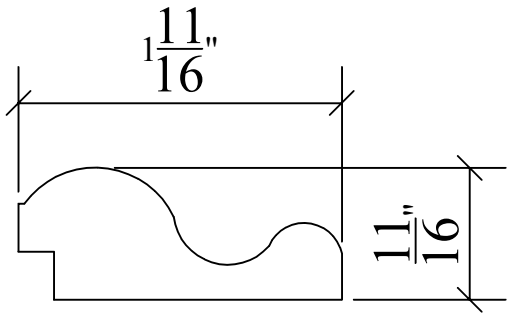

BB-49

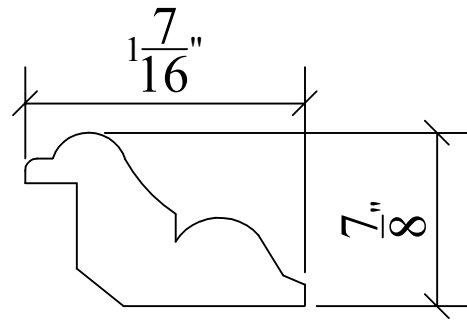

BB-50

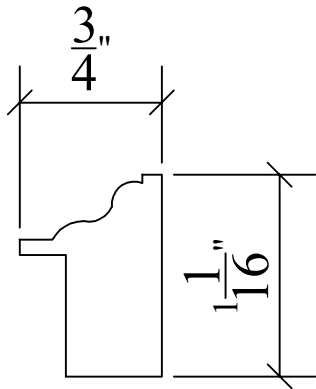

BB-51

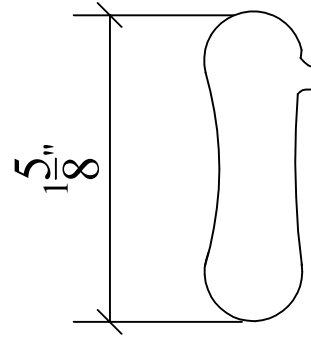

BB-52

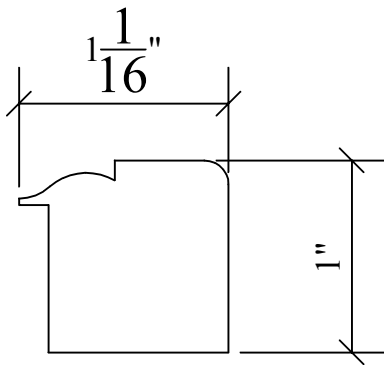

BB-53

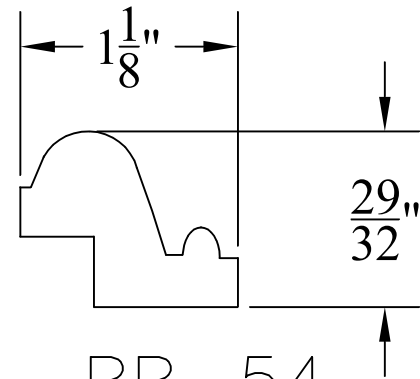

BB-54